



Product Specification

G213UAN01.1

AU OPTRONICS CORPORATION

() Preliminary Specifications

(V) Final Specifications

Module	21.3 Inch Color TFT-LCD
Model Name	G213UAN01.1

Customer	Date
_____	_____
Checked & Approved by	Date
_____	_____
Customer's sign back page	

Approved by	Date
<i>Jason CL Pan</i>	<u>Aug. 25, 2022</u>
Prepared by	Date
<i>Livia Huang</i>	<u>Aug. 25, 2022</u>
General Display Business Division / AU Optronics corporation	



Contents

1. Operating Precautions 5

2. General Description 6

 2.1 Display Characteristics..... 6

 2.2 Optical Characteristics..... 7

3. Functional Block Diagram 10

4. Absolute Maximum Ratings 11

 4.1 Absolute Ratings of TFT LCD Module 11

 4.2 Absolute Ratings of Environment 11

5. Electrical Characteristics 12

 5.1 TFT LCD Module 12

 5.2 Backlight Unit 15

6. Signal Characteristic 17

 6.1 Pixel Format Image..... 17

 6.2 LVDS Data Format..... 17

 6.3 Signal Description..... 19

 6.4 Interface Timing 21

 6.5 Power ON/OFF Sequence..... 23

7. Reliability Test Criteria 24

8. Mechanical Characteristics 25

 8.1 LCM Outline Dimension 25

9. Label and Packaging..... 27

 9.1 Shipping Label (on the rear side of TFT-LCD display) 27

 9.2 Carton Package 27

10 Safety 28

 10.1 Sharp Edge Requirements 28

 10.2 Materials 28

 10.3 Capacitors 28

 10.4 National Test Lab Requirement 28

Record of Revision

Version	Date (yyyy.mm.dd)	Page	Old description	New Description																																																																																																																																																																														
00	2021.10.13	-	First edition																																																																																																																																																																															
01	2021.12.30	6 7 11 12 15	<p>2.1 Display Characteristics</p> <p>Physical Size [mm] 456.0 (H) x 349.5 (V) x 22.0 (D) (Typ)</p> <p>2.2 Optical Characteristics</p> <table border="1"> <tr> <td rowspan="7">Color / Chromaticity Coordinates (CIE 1931)</td> <td>Red x</td> <td>(0.620)</td> <td>(0.650)</td> <td>(0.680)</td> </tr> <tr> <td>Red y</td> <td>(0.300)</td> <td>(0.330)</td> <td>(0.360)</td> </tr> <tr> <td>Green x</td> <td>(0.280)</td> <td>(0.310)</td> <td>(0.340)</td> </tr> <tr> <td>Green y</td> <td>(0.610)</td> <td>(0.640)</td> <td>(0.670)</td> </tr> <tr> <td>Blue x</td> <td>(0.120)</td> <td>(0.150)</td> <td>(0.180)</td> </tr> <tr> <td>Blue y</td> <td>(0.030)</td> <td>(0.060)</td> <td>(0.090)</td> </tr> <tr> <td>White x</td> <td>0.269</td> <td>0.299</td> <td>0.329</td> </tr> <tr> <td>White y</td> <td>0.285</td> <td>0.315</td> <td>0.345</td> </tr> </table> <p>4.1 Absolute Ratings of TFT LCD Module Permanent damage may occur if exceeding the following maximum rating.</p> <table border="1"> <tr> <th>Symbol</th> <th>Description</th> <th>Min</th> <th>Max</th> <th>Unit</th> <th>Remark</th> </tr> <tr> <td>VDD</td> <td>Power Supply Input Voltage</td> <td>GND-0.3</td> <td>6.0</td> <td>[Volt]</td> <td>Ta=25°C</td> </tr> </table> <p>5.1 TFT LCD Module 5.1.1 Power Specification Input power specifications are shown as follows:</p> <table border="1"> <tr> <th>Symbol</th> <th>Parameter</th> <th>Min</th> <th>Typ</th> <th>Max</th> <th>Units</th> <th>Remark</th> </tr> <tr> <td>VDD</td> <td>Logic/LCD Drive Voltage</td> <td>10.8</td> <td>12</td> <td>13.2</td> <td>[Volt]</td> <td>±10%</td> </tr> <tr> <td>IDD</td> <td>VDD Current</td> <td></td> <td>0.7</td> <td>0.84</td> <td>[A]</td> <td>Vin=5V, White Pattern, at 60Hz</td> </tr> <tr> <td>Irush</td> <td>LCD Inrush Current</td> <td></td> <td></td> <td>5</td> <td>[A]</td> <td>Note 1</td> </tr> <tr> <td>PDD</td> <td>VDD Power</td> <td></td> <td>8.4</td> <td>10.1</td> <td>[Watt]</td> <td>Vin=5V, White Pattern, at 60Hz</td> </tr> <tr> <td>VDDrp</td> <td>Allowable Logic/LCD Drive Ripple Voltage</td> <td></td> <td></td> <td>500</td> <td>[mV] p-p</td> <td>With panel loading</td> </tr> </table> <p>Note 1: Measurement condition:</p> <p>5.2 Backlight Unit</p>	Color / Chromaticity Coordinates (CIE 1931)	Red x	(0.620)	(0.650)	(0.680)	Red y	(0.300)	(0.330)	(0.360)	Green x	(0.280)	(0.310)	(0.340)	Green y	(0.610)	(0.640)	(0.670)	Blue x	(0.120)	(0.150)	(0.180)	Blue y	(0.030)	(0.060)	(0.090)	White x	0.269	0.299	0.329	White y	0.285	0.315	0.345	Symbol	Description	Min	Max	Unit	Remark	VDD	Power Supply Input Voltage	GND-0.3	6.0	[Volt]	Ta=25°C	Symbol	Parameter	Min	Typ	Max	Units	Remark	VDD	Logic/LCD Drive Voltage	10.8	12	13.2	[Volt]	±10%	IDD	VDD Current		0.7	0.84	[A]	Vin=5V, White Pattern, at 60Hz	Irush	LCD Inrush Current			5	[A]	Note 1	PDD	VDD Power		8.4	10.1	[Watt]	Vin=5V, White Pattern, at 60Hz	VDDrp	Allowable Logic/LCD Drive Ripple Voltage			500	[mV] p-p	With panel loading	<p>2.1 Display Characteristics</p> <p>Physical Size [mm] 456.0 (H) x 349.5 (V) x 17.6 (D) (Typ)</p> <p>2.2 Optical Characteristics</p> <table border="1"> <tr> <td rowspan="7">Color / Chromaticity Coordinates (CIE 1931)</td> <td>Red x</td> <td>(0.625)</td> <td>(0.656)</td> <td>(0.686)</td> </tr> <tr> <td>Red y</td> <td>(0.300)</td> <td>(0.330)</td> <td>(0.360)</td> </tr> <tr> <td>Green x</td> <td>(0.285)</td> <td>(0.315)</td> <td>(0.345)</td> </tr> <tr> <td>Green y</td> <td>(0.610)</td> <td>(0.640)</td> <td>(0.670)</td> </tr> <tr> <td>Blue x</td> <td>(0.120)</td> <td>(0.150)</td> <td>(0.180)</td> </tr> <tr> <td>Blue y</td> <td>(0.029)</td> <td>(0.059)</td> <td>(0.089)</td> </tr> <tr> <td>White x</td> <td>0.269</td> <td>0.299</td> <td>0.329</td> </tr> <tr> <td>White y</td> <td>0.285</td> <td>0.315</td> <td>0.345</td> </tr> </table> <p>4.1 Absolute Ratings of TFT LCD Module Permanent damage may occur if exceeding the following maximum rating.</p> <table border="1"> <tr> <th>Symbol</th> <th>Description</th> <th>Min</th> <th>Max</th> <th>Unit</th> <th>Remark</th> </tr> <tr> <td>VDD</td> <td>Power Supply Input Voltage</td> <td>10.8</td> <td>13.2</td> <td>[Volt]</td> <td>Ta=25°C</td> </tr> </table> <p>5.1 TFT LCD Module 5.1.1 Power Specification Input power specifications are shown as follows:</p> <table border="1"> <tr> <th>Symbol</th> <th>Parameter</th> <th>Min</th> <th>Typ</th> <th>Max</th> <th>Units</th> <th>Remark</th> </tr> <tr> <td>VDD</td> <td>Logic/LCD Drive Voltage</td> <td>10.8</td> <td>12</td> <td>13.2</td> <td>[Volt]</td> <td>±10%</td> </tr> <tr> <td>IDD</td> <td>VDD Current</td> <td></td> <td>0.7</td> <td>0.84</td> <td>[A]</td> <td>Vin=12V, White Pattern, at 60Hz</td> </tr> <tr> <td>Irush</td> <td>LCD Inrush Current</td> <td></td> <td></td> <td>5</td> <td>[A]</td> <td>Note 1</td> </tr> <tr> <td>PDD</td> <td>VDD Power</td> <td></td> <td>8.4</td> <td>10.1</td> <td>[Watt]</td> <td>Vin=12V, White Pattern, at 60Hz</td> </tr> <tr> <td>VDDrp</td> <td>Allowable Logic/LCD Drive Ripple Voltage</td> <td></td> <td></td> <td>500</td> <td>[mV] p-p</td> <td>With panel loading</td> </tr> </table> <p>Note 1: Measurement condition:</p> <p>5.2 Backlight Unit</p>	Color / Chromaticity Coordinates (CIE 1931)	Red x	(0.625)	(0.656)	(0.686)	Red y	(0.300)	(0.330)	(0.360)	Green x	(0.285)	(0.315)	(0.345)	Green y	(0.610)	(0.640)	(0.670)	Blue x	(0.120)	(0.150)	(0.180)	Blue y	(0.029)	(0.059)	(0.089)	White x	0.269	0.299	0.329	White y	0.285	0.315	0.345	Symbol	Description	Min	Max	Unit	Remark	VDD	Power Supply Input Voltage	10.8	13.2	[Volt]	Ta=25°C	Symbol	Parameter	Min	Typ	Max	Units	Remark	VDD	Logic/LCD Drive Voltage	10.8	12	13.2	[Volt]	±10%	IDD	VDD Current		0.7	0.84	[A]	Vin=12V, White Pattern, at 60Hz	Irush	LCD Inrush Current			5	[A]	Note 1	PDD	VDD Power		8.4	10.1	[Watt]	Vin=12V, White Pattern, at 60Hz	VDDrp	Allowable Logic/LCD Drive Ripple Voltage			500	[mV] p-p	With panel loading
Color / Chromaticity Coordinates (CIE 1931)	Red x	(0.620)	(0.650)		(0.680)																																																																																																																																																																													
	Red y	(0.300)	(0.330)		(0.360)																																																																																																																																																																													
	Green x	(0.280)	(0.310)		(0.340)																																																																																																																																																																													
	Green y	(0.610)	(0.640)		(0.670)																																																																																																																																																																													
	Blue x	(0.120)	(0.150)		(0.180)																																																																																																																																																																													
	Blue y	(0.030)	(0.060)		(0.090)																																																																																																																																																																													
	White x	0.269	0.299	0.329																																																																																																																																																																														
White y	0.285	0.315	0.345																																																																																																																																																																															
Symbol	Description	Min	Max	Unit	Remark																																																																																																																																																																													
VDD	Power Supply Input Voltage	GND-0.3	6.0	[Volt]	Ta=25°C																																																																																																																																																																													
Symbol	Parameter	Min	Typ	Max	Units	Remark																																																																																																																																																																												
VDD	Logic/LCD Drive Voltage	10.8	12	13.2	[Volt]	±10%																																																																																																																																																																												
IDD	VDD Current		0.7	0.84	[A]	Vin=5V, White Pattern, at 60Hz																																																																																																																																																																												
Irush	LCD Inrush Current			5	[A]	Note 1																																																																																																																																																																												
PDD	VDD Power		8.4	10.1	[Watt]	Vin=5V, White Pattern, at 60Hz																																																																																																																																																																												
VDDrp	Allowable Logic/LCD Drive Ripple Voltage			500	[mV] p-p	With panel loading																																																																																																																																																																												
Color / Chromaticity Coordinates (CIE 1931)	Red x	(0.625)	(0.656)	(0.686)																																																																																																																																																																														
	Red y	(0.300)	(0.330)	(0.360)																																																																																																																																																																														
	Green x	(0.285)	(0.315)	(0.345)																																																																																																																																																																														
	Green y	(0.610)	(0.640)	(0.670)																																																																																																																																																																														
	Blue x	(0.120)	(0.150)	(0.180)																																																																																																																																																																														
	Blue y	(0.029)	(0.059)	(0.089)																																																																																																																																																																														
	White x	0.269	0.299	0.329																																																																																																																																																																														
White y	0.285	0.315	0.345																																																																																																																																																																															
Symbol	Description	Min	Max	Unit	Remark																																																																																																																																																																													
VDD	Power Supply Input Voltage	10.8	13.2	[Volt]	Ta=25°C																																																																																																																																																																													
Symbol	Parameter	Min	Typ	Max	Units	Remark																																																																																																																																																																												
VDD	Logic/LCD Drive Voltage	10.8	12	13.2	[Volt]	±10%																																																																																																																																																																												
IDD	VDD Current		0.7	0.84	[A]	Vin=12V, White Pattern, at 60Hz																																																																																																																																																																												
Irush	LCD Inrush Current			5	[A]	Note 1																																																																																																																																																																												
PDD	VDD Power		8.4	10.1	[Watt]	Vin=12V, White Pattern, at 60Hz																																																																																																																																																																												
VDDrp	Allowable Logic/LCD Drive Ripple Voltage			500	[mV] p-p	With panel loading																																																																																																																																																																												

Version	Date (yyyy.mm.dd)	Page	Old description	New Description																																
01	2021.12.30	17 18 22 24 25 26	<p>6.3 Pixel Format Image Following figure shows the relationship between the input signals and LCD pixel format.</p> <p>6.2 LVDS Data Format</p> <p>6.4.2 Input Timing Diagram</p> <p>8.1 LCM Outline Dimension</p>	<p>6.1 Pixel Format Image Following figure shows the relationship between the input signals and LCD pixel format</p> <p>6.2 LVDS Data Format</p> <p>8.1 LCM Outline Dimension</p> <p>8 Bits Color Bit Order</p> <table border="1"> <tr><td>MSB</td><td>R7</td><td>G7</td><td>B7</td></tr> <tr><td></td><td>R6</td><td>G6</td><td>B6</td></tr> <tr><td></td><td>R5</td><td>G5</td><td>B5</td></tr> <tr><td></td><td>R4</td><td>G4</td><td>B4</td></tr> <tr><td></td><td>R3</td><td>G3</td><td>B3</td></tr> <tr><td></td><td>R2</td><td>G2</td><td>B2</td></tr> <tr><td></td><td>R1</td><td>G1</td><td>B1</td></tr> <tr><td>LSB</td><td>R0</td><td>G0</td><td>B0</td></tr> </table> <p>Note1: Normally DE mode only. VS and HS on EVEN channel are not used. Note2: Please follow VESA. Note3: 8-bits signal input.</p>	MSB	R7	G7	B7		R6	G6	B6		R5	G5	B5		R4	G4	B4		R3	G3	B3		R2	G2	B2		R1	G1	B1	LSB	R0	G0	B0
MSB	R7	G7	B7																																	
	R6	G6	B6																																	
	R5	G5	B5																																	
	R4	G4	B4																																	
	R3	G3	B3																																	
	R2	G2	B2																																	
	R1	G1	B1																																	
LSB	R0	G0	B0																																	
02	2022.04.22	5	ESD (Electro Static "Discharge")	ESD (Electro Static "Discharge")																																
		23	Note 3-6: Voltage of "VDO"	Note 3-6: Voltage of "VDD"																																
		6	Weight 2800typ	Weight 2300typ																																
03	2022.07.29	7	Uniformity:80% min	Add 85% typ																																
04	2022.08.03	15	Backlight connector: C11408M1HRL-NH	Backlight connector C11408M1HRN-NH																																
1.0	2022.08.25		Preliminary Specifications (ver 0.4)	Final Specifications (ver 1.0)																																

1. Operating Precautions

- 1) Since front polarizer is easily damaged, please be cautious and not to scratch it.
- 2) Be sure to turn off power supply when inserting or disconnecting from input connector.
- 3) Wipe off water drop immediately. Long contact with water may cause discoloration or spots.
- 4) When the panel surface is soiled, wipe it with absorbent cotton or soft cloth.
- 5) Since the panel is made of glass, it may be broken or cracked if dropped or bumped on hard surface.
- 6) To avoid ESD (Electro Static Discharge) damage, be sure to ground yourself before handling TFT-LCD Module.
- 7) Do not open nor modify the module assembly.
- 8) Do not press the reflector sheet at the back of the module to any direction.
- 9) In case if a module has to be put back into the packing container slot after it was taken out from the container, do not press the center of the LED light bar edge. Instead, press at the far ends of the LED light bar edge softly. Otherwise the TFT Module may be damaged.
- 10) At the insertion or removal of the Signal Interface Connector, be sure not to rotate nor tilt the Interface Connector of the TFT Module.
- 11) TFT-LCD Module is not allowed to be twisted & bent even force is added on module in a very short time. Please design your display product well to avoid external force applying to module by end-user directly.
- 12) Small amount of materials having no flammability grade is used in the LCD module. The LCD module should be supplied by power complied with requirements of Limited Power Source (IEC60950 or UL1950), or be applied exemption.
- 13) Severe temperature condition may result in different luminance, response time and lamp ignition voltage.
- 14) Continuous operating TFT-LCD display under low temperature environment may accelerate lamp exhaustion and reduce luminance dramatically.
- 15) The data on this specification sheet is applicable when LCD module is placed in landscape position.
- 16) Continuous displaying fixed pattern may induce image sticking. It's recommended to use screen saver or shuffle content periodically if fixed pattern is displayed on the screen.

2. General Description

G213UAN01.1 is a Color Active Matrix Liquid Crystal Display composed of a TFT-LCD panel and a backlight system. The screen format is intended to support the UXGA (1600(H) x 1200(V)) screen and 16.7M colors. All input signals are 2-channel LVDS interface compatible.

2.1 Display Characteristics

The following items are characteristics summary on the table under 25 °C condition:

Items	Unit	Specifications
Screen Diagonal	[inch]	21.3"
Active Area	[mm]	432.0 x 324.0
Resolution		1600(x3) x 1200
Pixel Pitch	[mm]	0.270 (H) x 0.270 (V)
Pixel Arrangement		R.G.B. Vertical Stripe
Display Mode		AHVA
Nominal Input Voltage VDD	[Volt]	12V
Power Consumption	[Watt]	Total: 42.205 (Max) LCD module: 10.1W (white pattern) BLU: 32.105W
Weight	[Grams]	2300g (typ.)
Physical Size	[mm]	456.0 (H) x 349.5 (V) x 17.6 (D) (Typ)
Electrical Interface		LVDS
Surface Treatment		Anti-Glare
Support Color		16.7 M Colors , True 8 Bit (RGB)
Temperature Range		
Operating	[°C]	0 to +50
Storage (Non-Operating)	[°C]	-20 to +60
RoHS Compliance		RoHS Compliance

2.2 Optical Characteristics

The optical characteristics are measured under stable conditions at 25 °C (Room Temperature).

Test Condition:

1. Equipment setup: Please refer to Note 1
2. Panel Lighting: 30 minutes
3. VDD=5.0V , Fv=60Hz, Is = 60mA

Item	Unit	Conditions	Min.	Typ.	Max.	Note
White Luminance	cd/m ²	ILED=70mA(center point)	800	1000		
Uniformity	%	9 points	80	85		
Contrast Ratio	--		1260	1800		
Response Time	msec	Rising		10	20	4
		Falling		10	20	
		Rising + Falling		20	40	
Viewing Angle	degree	Horizontal CR >= 10	(Right)	85	89	5
			(Left)	85	89	
		Vertical CR >= 10	(Upper)	85	89	
			(Lower)	85	89	
Color / Chromaticity Coordinates (CIE 1931)	--	Red x	(0.626)	(0.656)	(0.686)	6
		Red y	(0.300)	(0.330)	(0.360)	
		Green x	(0.285)	(0.315)	(0.345)	
		Green y	(0.610)	(0.640)	(0.670)	
		Blue x	(0.120)	(0.150)	(0.180)	
		Blue y	(0.029)	(0.059)	(0.089)	
		White x	0.269	0.299	0.329	
		White y	0.285	0.315	0.345	
Color Gamut	%	sRGB		100%		

Note 1: Measurement method

The LCD module should be stabilized at given temperature for 30 minutes to avoid abrupt temperature change during measuring (at surface 35°C). In order to stabilize the luminance, the measurement should be executed after lighting Backlight for 30 minutes in a stable, windless and dark room.

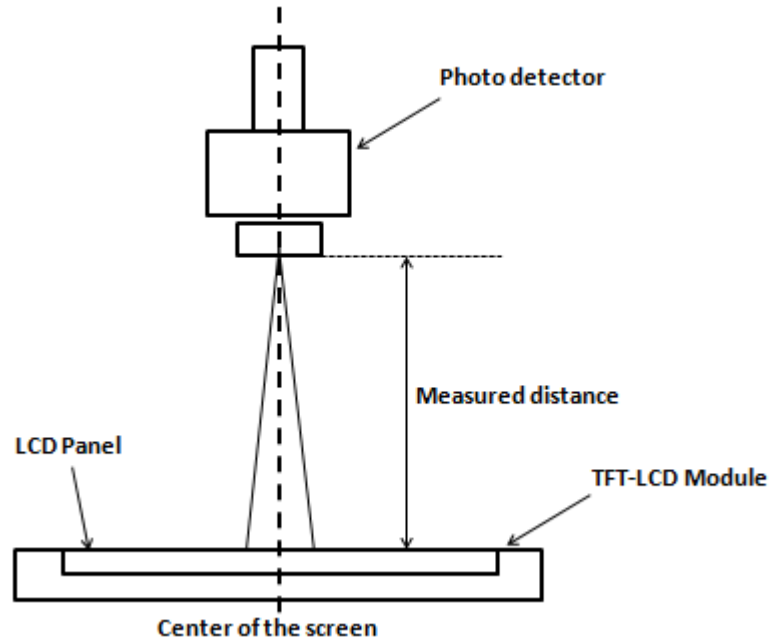

Note 2: Luminance uniformity of these 9 points is defined as below and measured by SR-3

The luminance uniformity of 9 points is defined by dividing the minimum luminance values by the maximum test point luminance

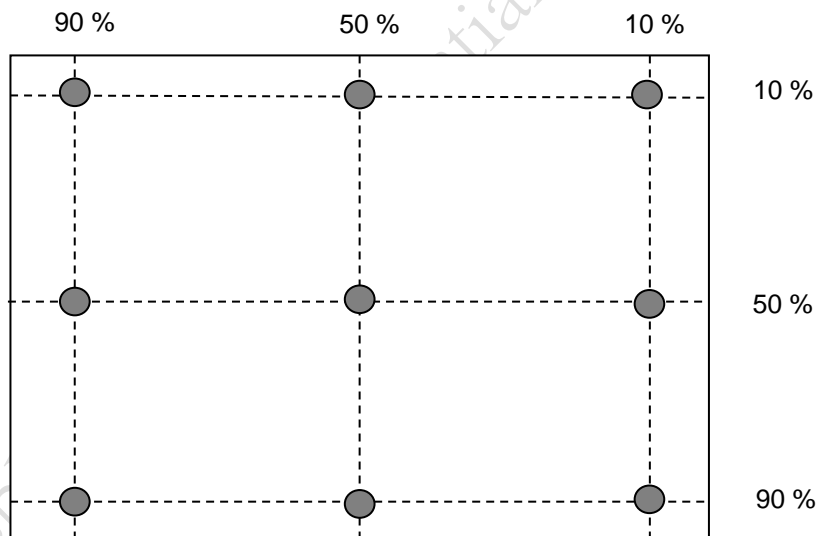

$$\text{Uniformity} = \frac{\text{Minimum Luminance in 9 points (1-9)}}{\text{Maximum Luminance in 9 Points (1-9)}}$$

Note 3: Contrast ratio is measured by SR-3

Definition of contrast ratio (CR):

$$\text{Contrast ratio (CR)} = \frac{\text{Brightness on the "White" state}}{\text{Brightness on the "Black" state}}$$

Note 4: Definition of Response time

The output signals of photo detector are measured when the input signals are changed from “White” to “Black” (falling time) and from “Black” to “White” (rising time), respectively. The response time interval is between 10% and 90% of amplitudes. Please refer to the figure as below.

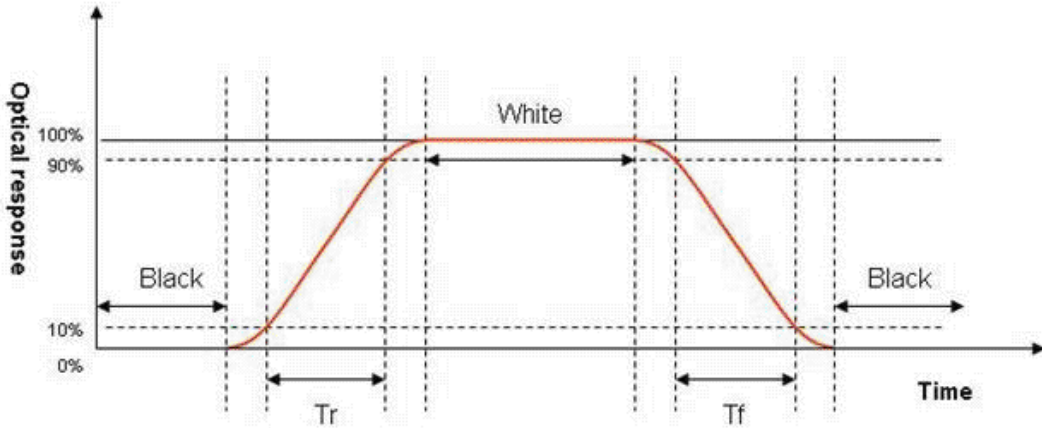

Note 5: Definition of viewing angle measured by ELDIM

Viewing angle is the measurement of contrast ratio ≥ 10 , at the screen center, over a 180° horizontal and 180° vertical range (off-normal viewing angles). The 180° viewing angle range is broken down as below: 90° (θ) horizontal left and right, and 90° (ϕ) vertical high (up) and low (down). The measurement direction is typically perpendicular to the display surface with the screen rotated to its center to develop the desired measurement viewing angle.

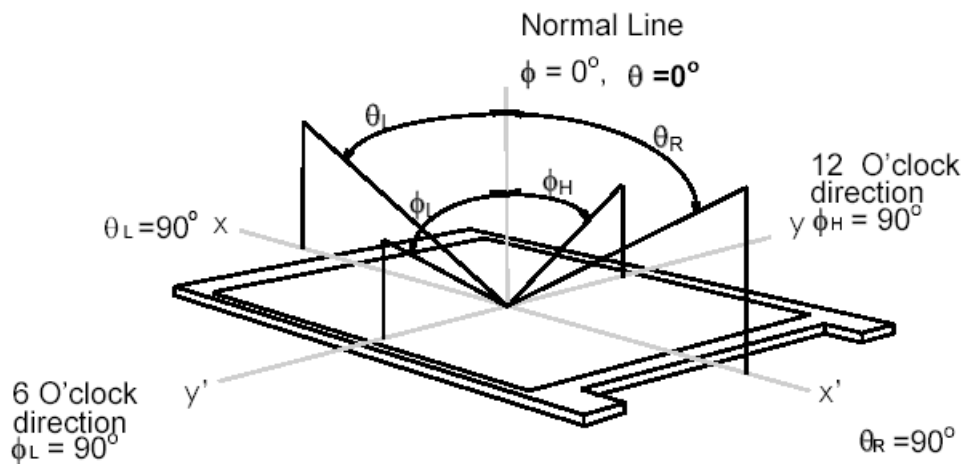

Note 6: Color chromaticity and coordinates (CIE) is measured by SR-3

3. Functional Block Diagram

The following diagram shows the functional block of the 21.3 inch color TFT/LCD module:

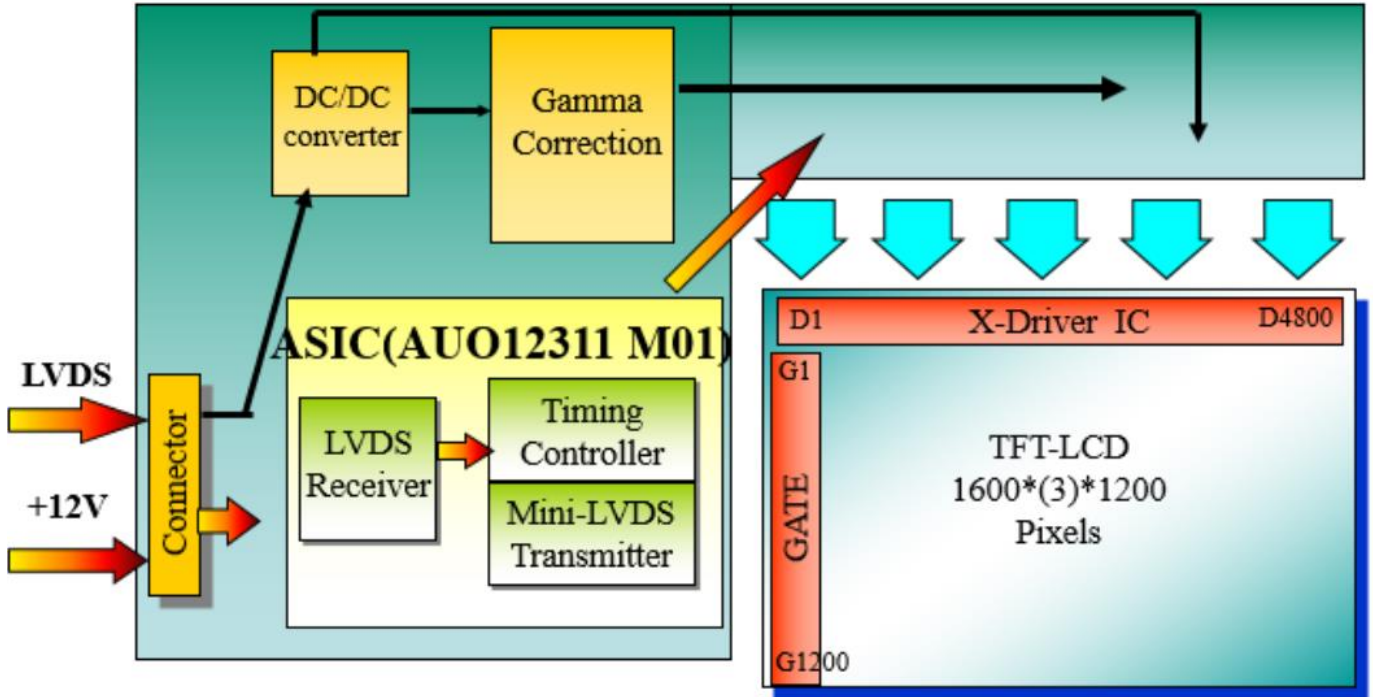

AUO Display Plus Confidential

4. Absolute Maximum Ratings

4.1 Absolute Ratings of TFT LCD Module

Permanent damage may occur if exceeding the following maximum rating.

Symbol	Description	Min	Max	Unit	Remark
VDD	Power Supply Input Voltage	10.8	13.2	[Volt]	Ta=25°C

4.2 Absolute Ratings of Environment

Item	Symbol	Min.	Max.	Unit	Conditions
Operating	TOP	0	+50	[°C]	Note
Operation Humidity	HOP	5	90	[%RH]	
Storage	TST	-20	+60	[°C]	
Storage Humidity	HST	5	90	[%RH]	

Note 1: Within Ta= 25°C

Note 2: Permanent damage to the device may occur if exceed maximum values

Note 3: For quality performance, please refer to AUO IIS (Incoming Inspection Standard).

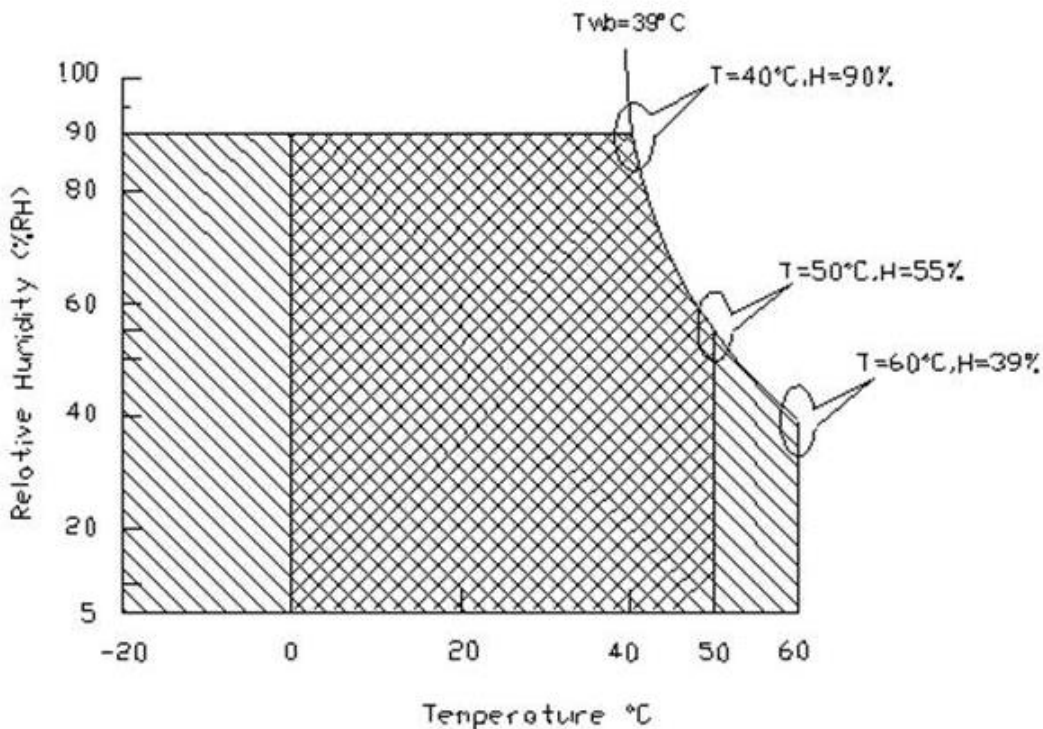

5. Electrical Characteristics

5.1 TFT LCD Module

5.1.1 Power Specification

Input power specifications are shown as follows:

Symbol	Parameter	Min	Typ	Max	Units	Remark
VDD	Logic/LCD Drive Voltage	10.8	12	13.2	[Volt]	±10%
IDD	VDD Current		0.7	0.84	[A]	Vin=12V, White Pattern, at 60Hz
Irush	LCD Inrush Current			5	[A]	Note 1
PDD	VDD Power		8.4	10.1	[Watt]	Vin=12V, White Pattern, at 60Hz
VDDrp	Allowable Logic/LCD Drive Ripple Voltage			500	[mV] p-p	With panel loading

Note 1: Measurement condition:

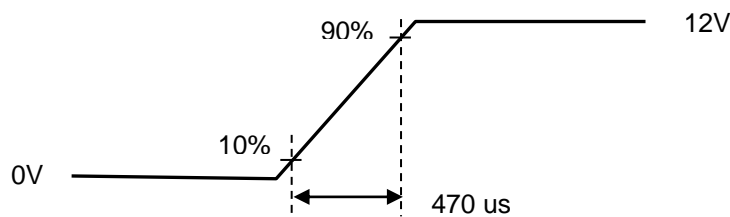
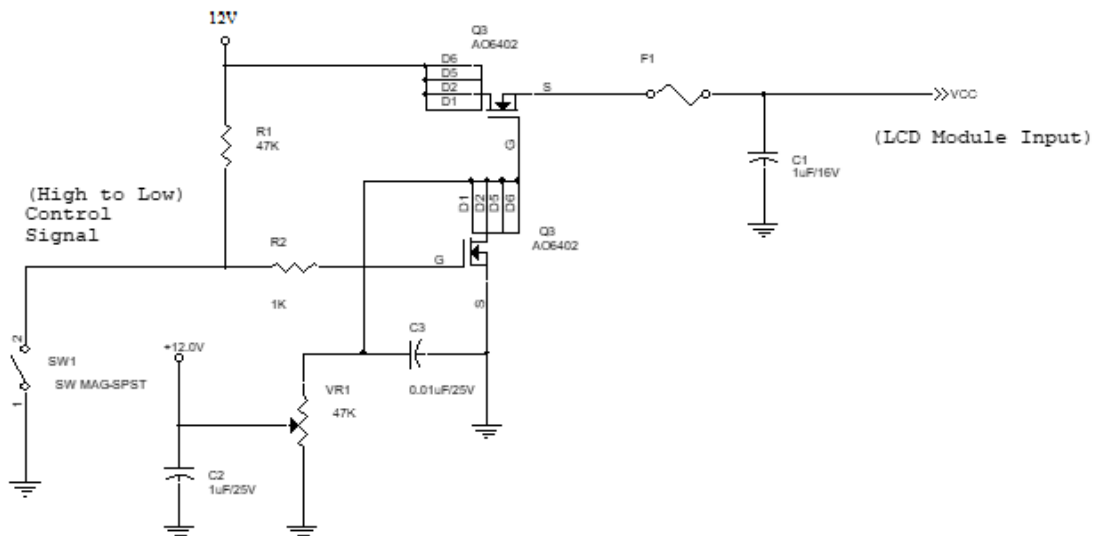

VDD rising time

5.1.2 LVDS DC Signal Electrical Characteristics

Input signals shall be low or Hi-Z state when VDD is off.

Symbol	Item	Min.	Typ.	Max.	Unit	Remark
V _{TH}	Differential Input High Threshold	-	-	+100	[mV]	V _{CM} =1.2V
V _{TL}	Differential Input Low Threshold	-100	-	-	[mV]	V _{CM} =1.2V
VID	Input Differential Voltage	100	-	600	[mV]	
V _{ICM}	Differential Input Common Mode Voltage	+1.0	+1.2	+1.5	[V]	V _{TH} /V _{TL} =+/-200mV

Note: LVDS Signal Waveform.

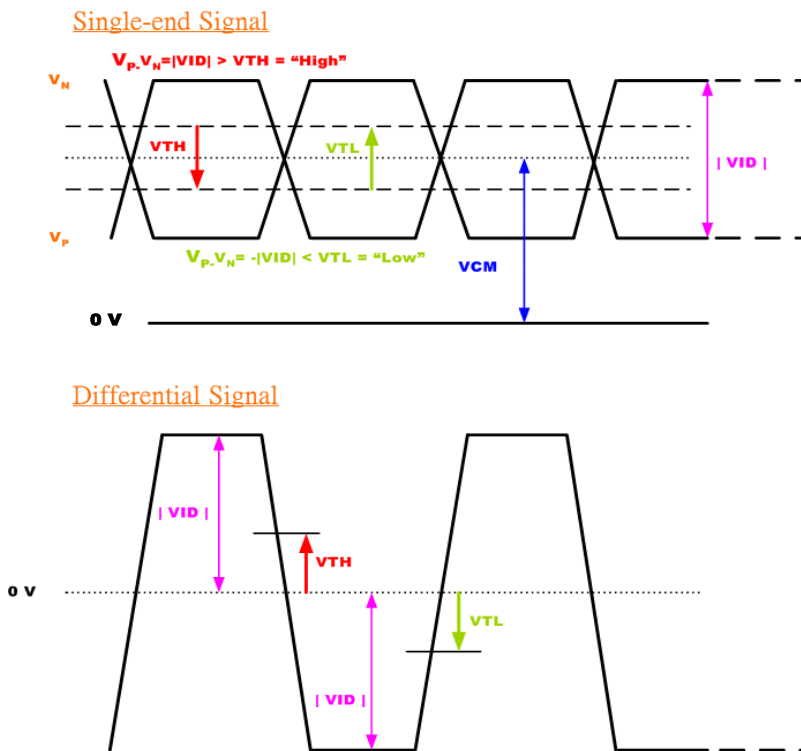

Note: AC Characteristics

Symbol	Description	Min	Max	Unit	Remark
F _{DEV}	Maximum deviation of input clock frequency during Spread Spectrum	-	± 3	%	
F _{MOD}	Maximum modulation frequency of input clock during Spread Spectrum	-	200	KHz	

Note: Fclk- LVDS Clock Frequency.

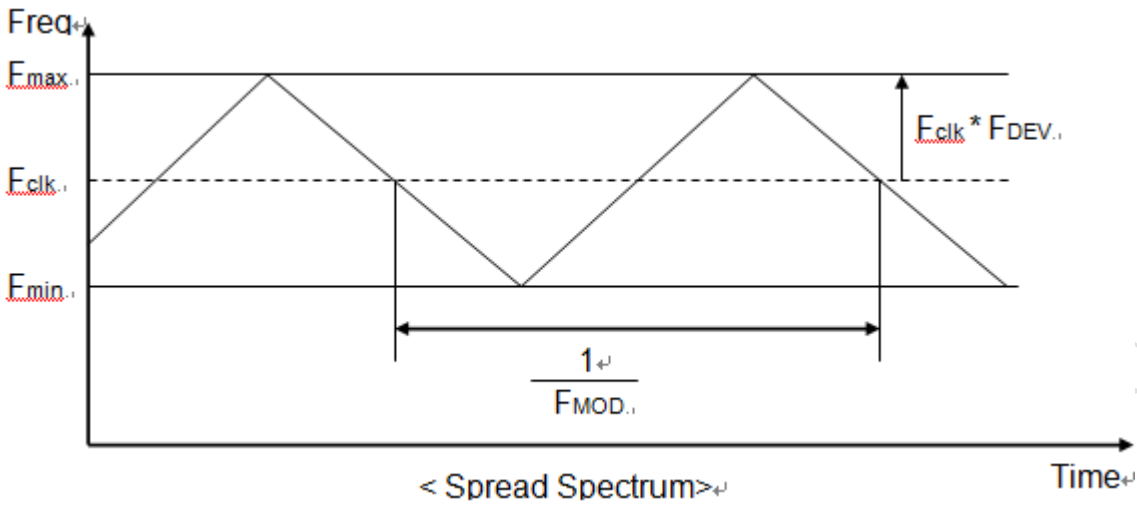

AUO Display Plus Confidential for Pro

5.2 Backlight Unit

5.2.1 LED Backlight Unit

Connector Name / Designation	LED Connector
Manufacturer	Cvilux
Backlight connector	CI1408M1HRN-NH
Mating connector	CI1408SL000-NH

5.2.2 Pin Assignment

Pin #	Symbol	Description
1	Ch1	IRLED (current out)
2	Ch2	IRLED (current out)
3	Ch3	IRLED (current out)
4	V _{SLED}	VLED (voltage in)
5	V _{SLED}	VLED (voltage in)
6	Ch4	IRLED (current out)
7	Ch5	IRLED (current out)
8	Ch6	IRLED (current out)

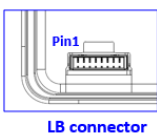
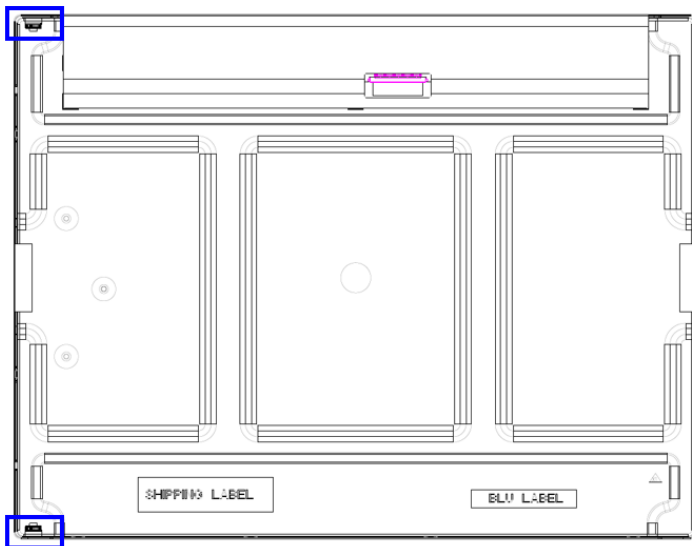

5.2.3 Parameter guideline for LED

Following characteristics are measured under a stable condition using an inverter at 25°C (Room Temperature):

LED characteristics

Symbol	Parameter	Min.	Typ.	Max.	Unit	Remark
I_L	LED Supply Current	-	70	-	[mA]	Ta = 25°C,
V_L	LED Supply Voltage	-	37.05	38.22	[Volt]	I _F = 70mA, Ta = 25°C
P_{BLU}	LED Power Consumption	-	31.122	32.105	[Watt]	I _F = 70mA, Ta = 25°C
L_L	LED Life Time	50,000	-	-	Hrs	I _F = 70mA, Ta = 25°C

Note 1: Ta means ambient temperature of TFT-LCD module.

Note 2: I_L , V_L are defined for one channel LED. There are 6 LED channel in back light unit.

Note 3: LED light bar is 78 LEDs (6 strings, 13pcs for each string)

Note 4: There are two light bars in back light unit.

Note 5: The voltage capacity of LED driver IC must be over max. of LED Voltage.

Note 6: Definition of life time: Brightness becomes to 50% of its original value.

Note 7: If module is driven by high current or at high ambient temperature & humidity condition. The operating life will reduce.

Note 8: Recommendation for LED driver power design – Due to there are electrical property deviation in LED and monitor set system component after long time operation, AUO strongly recommend the design value of LED driver board OVP (Over Voltage Protection) should be 10% higher than max value of LED string voltage (V_s) at least.

6. Signal Characteristic

6.1 Pixel Format Image

Following figure shows the relationship between the input signals and LCD pixel format.

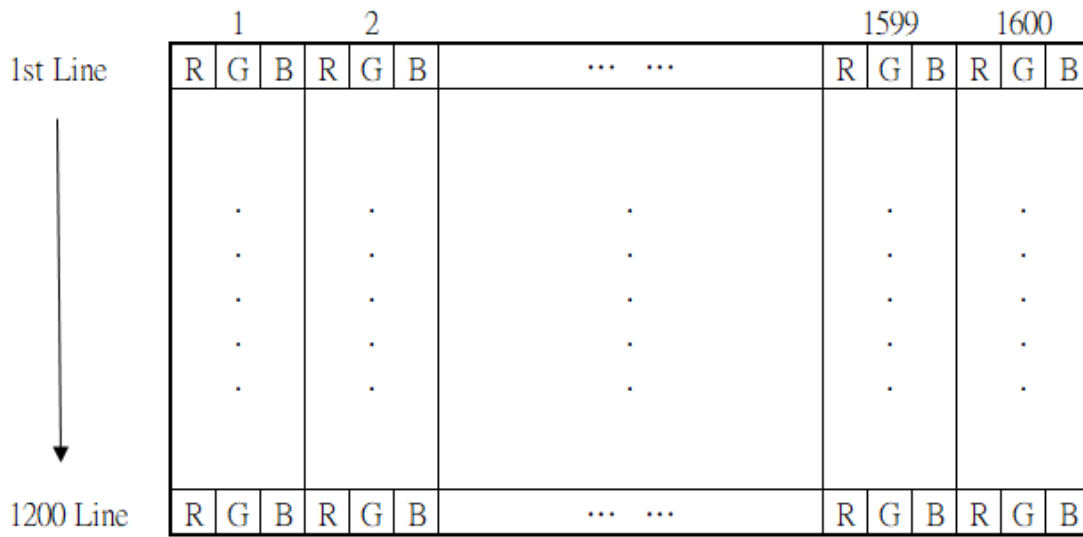

AUO Display Plus Confidential fc.

6.2 LVDS Data Format

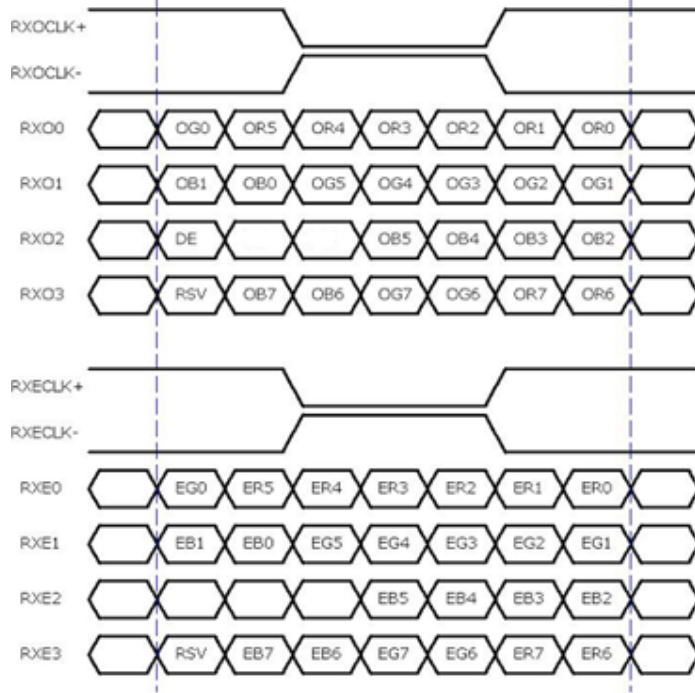

8 Bit Color Bit Order			
MSB	R7	G7	B7
	R6	G6	B6
	R5	G5	B5
	R4	G4	B4
	R3	G3	B3
	R2	G2	B2
	R1	G1	B1
LSB	R0	G0	B0

Note1: Normally DE mode only. VS and HS on EVEN channel are not used.

Note2: Please follow VESA.

Note3: 8-bits signal input

AUO Display Plus Confidential for Proc

6.3 Signal Description

6.3.1 TFT LCD Module: LVDS Connector

TFT-LCD Connector (CNT1)	Manufacturer	JAE	
	Part Number	FI-XB30SSLA-HF15	
Mating Connector (CNT1)	Manufacturer	JAE	STM
	Part Number	JAE_FI-X30H	STM_PFSKX10001N30A

6.3.2 Connector Pin Assignment

■ LVDS CN1

PIN #	Symbol	Description	Remark
1	RxO0-	Negative LVDS differential data input (Odd data)	
2	RxO0+	Positive LVDS differential data input (Odd data)	
3	RxO1-	Negative LVDS differential data input (Odd data)	
4	RxO1+	Positive LVDS differential data input (Odd data)	
5	RxO2-	Negative LVDS differential data input (Odd data)	
6	RxO2+	Positive LVDS differential data input (Odd data)	
7	GND	Ground	
8	RxOCLK-	Negative LVDS differential clock input (Odd clock)	
9	RxOCLK+	Positive LVDS differential clock input (Odd clock)	
10	RxO3-	Negative LVDS differential data input (Odd data)	
11	RxO3+	Positive LVDS differential data input (Odd data)	
12	RxE0-	Negative LVDS differential data input (Even data)	
13	RxE0+	Positive LVDS differential data input (Even data)	
14	GND	Ground	
15	RxE1-	Negative LVDS differential data input (Even data)	
16	RxE1+	Positive LVDS differential data input (Even data)	
17	GND	Ground	
18	RxE2-	Negative LVDS differential data input (Even data)	
19	RxE2+	Positive LVDS differential data input (Even data)	
20	RxECLK-	Negative LVDS differential clock input (Even clock)	
21	RxECLK+	Positive LVDS differential clock input (Even clock)	
22	RxE3-	Negative LVDS differential data input (Even data)	
23	RxE3+	Positive LVDS differential data input (Even data)	
24	GND	Must Connect to GND	
25	NC	No connection (for AUO test only. Do not connect)	
26	NC	No connection (for AUO test only. Do not connect)	



Product Specification

G213UAN01.1

AU OPTRONICS CORPORATION

27	NC	No connection (for AUO test only. Do not connect)	
28	VDD	Power Supply Input Voltage	
29	VDD	Power Supply Input Voltage	
30	VDD	Power Supply Input Voltage	

AUO Display Plus Confidential for Promate Use Only

6.4 Interface Timing

6.4.1 Timing Characteristics

It only support DE mode and the input timing are shown as the following table.

Symbol	Description		Min.	Typ.	Max.	Unit	Remark
Tv	Vertical Section	Period	1229	1233	-	Th	
Tdisp (v)		Active	1200			Th	
Tblk (v)		Blanking	29	33	-	Th	
Fv		Frequency	58.5	60.0	61.5	Hz	
Th	Horizontal Section	Period	850	880	940	Tclk	
Tdisp (h)		Active	800			Tclk	
Tblk (h)		Blanking	50	80	140	Tclk	
Fh		Frequency	71.5	74.0	78.0	KHz	Note 3-3
Tclk	LVDS Clock	Period	14.81	15.36	16.13	ns	1/Fclk
Fclk		Frequency	62.0	65.1	67.5	MHz	Note 3-4

Note 3-3: The equation is listed as following. Please don't exceed the above recommended value.

$$Fh (\text{Min.}) = Fclk (\text{Min.}) / Th (\text{Min.});$$

$$Fh (\text{Typ.}) = Fclk (\text{Typ.}) / Th (\text{Typ.});$$

$$Fh (\text{Max.}) = Fclk (\text{Max.}) / Th (\text{Min.});$$

Note 3-4: The equation is listed as following. Please don't exceed the above recommended value.

$$Fclk (\text{Min.}) = Fv (\text{Min.}) \times Th (\text{Min.}) \times Tv (\text{Min.});$$

$$Fclk (\text{Typ.}) = Fv (\text{Typ.}) \times Th (\text{Typ.}) \times Tv (\text{Typ.});$$

$$Fclk (\text{Max.}) = Fv (\text{Max.}) \times Th (\text{Typ.}) \times Tv (\text{Typ.});$$

6.4.2 Input Timing Diagram

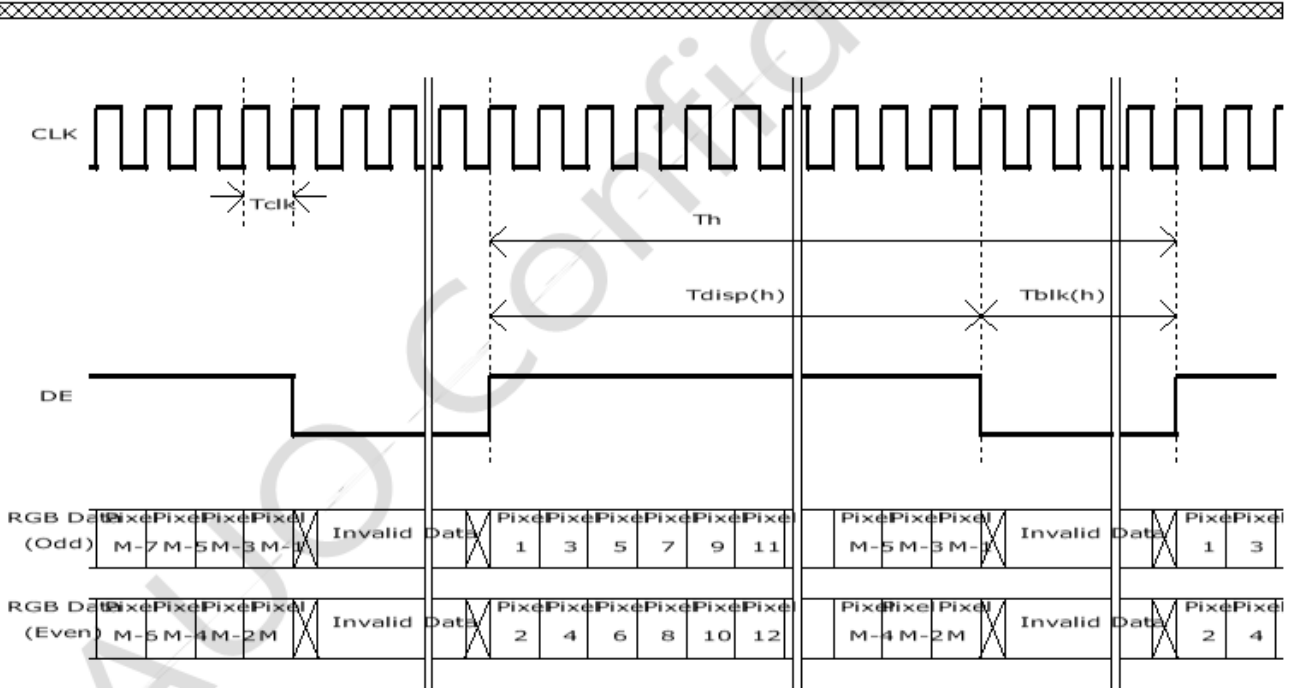
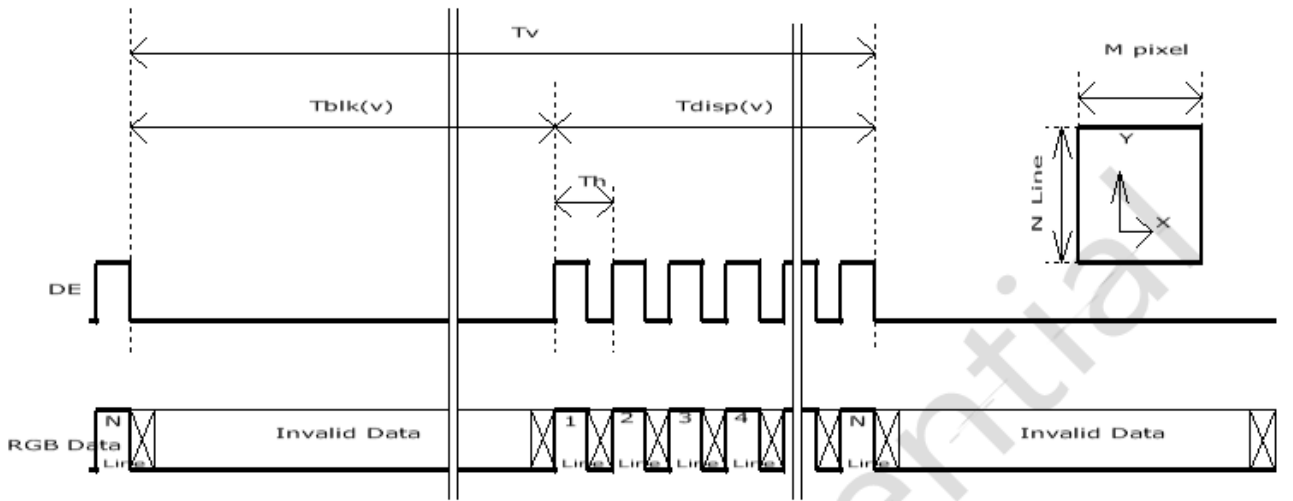

6.5 Power ON/OFF Sequence

VDD power, LVDS signal and backlight on/off sequence are as following. LVDS signals from any system shall be Hi-Z state when VDD is off.

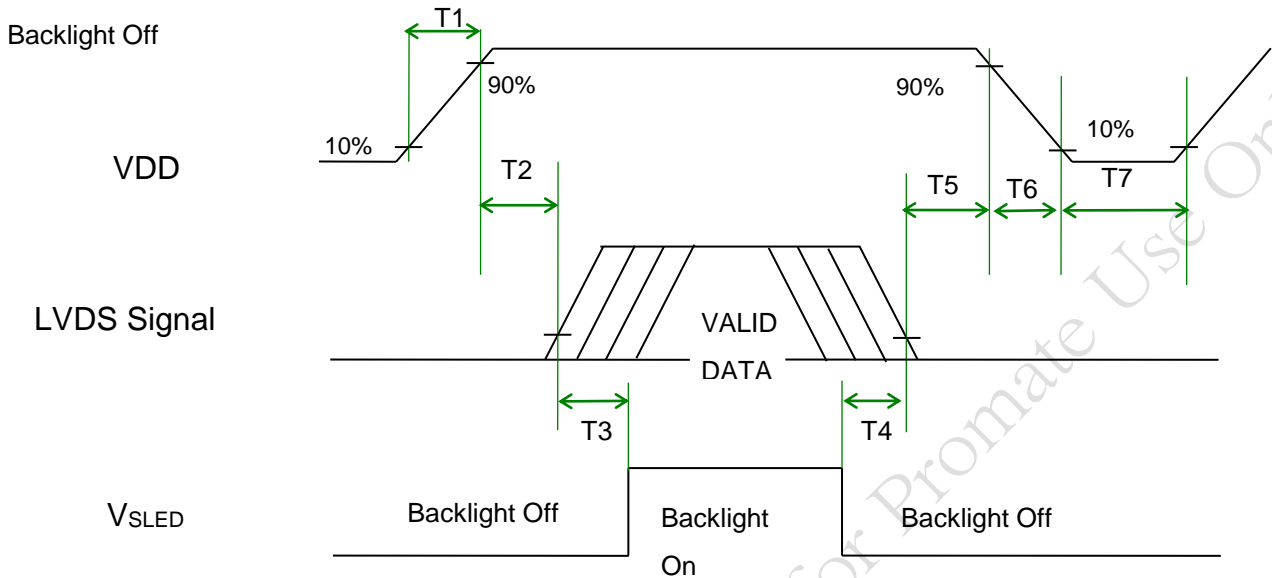

Power Sequence Timing

Symbol	Value			Unit	Remark
	Min.	Typ.	Max.		
T1	0.5	-	10	[ms]	
T2	0	-	50	[ms]	
T3	500	-	-	[ms]	
T4	100	-	-	[ms]	
T5	0		50	[ms]	Note 3-5
T6	0	-	200	[ms]	Note 3-6
T7	1000	-	-	[ms]	

Note 3-5 : Recommend setting T5 = 0ms to avoid electronic noise when VDD is off.

Note 3-6: Voltage of VDD must decay smoothly after power-off. (Customer system decide this value)

7. Reliability Test Criteria

Items	Required Condition	Note
Temperature Humidity Bias (THB)	Ta= 50°C, 80%RH, 300hours	
High Temperature Operation (HTO)	Ta= 50°C, 300hours	
Low Temperature Operation (LTO)	Ta= 0°C, 300hours	
High Temperature Storage (HTS)	Ta= 60°C, 300hours	
Low Temperature Storage (LTS)	Ta= -20°C, 300hours	
Vibration Test (Non-operation)	Acceleration: 1.5 Grms Wave: Random Frequency: 10 - 200 Hz Sweep: 30 Minutes each Axis (X, Y, Z)	
Shock Test (Non-operation)	Acceleration: 50 G Wave: Half-sine Active Time: 20 ms Direction: ±X, ±Y, ±Z (one time for each Axis)	
Drop Test	Height: 45.7cm, package test	
Thermal Shock Test (TST)	-20 °C /30min, 60/°C 30min, 100 cycles	1
On/Off Test	On/10sec, Off/10sec, 30,000 cycles	
ESD (Electrostatic Discharge)	Contact Discharge: ± 8KV, 150pF(330Ω) 1sec, 9 points, 25 times/ point.	2
	Air Discharge: ± 15KV, 150pF(330Ω) 1sec 9 points, 25 times/ point.	
Altitude Test	Operation:10,000 ft Non-Operation:30,000 ft	

Note 1: The TFT-LCD module will not sustain damage after being subjected to 100 cycles of rapid temperature change. A cycle of rapid temperature change consists of varying the temperature from -20°C to 50°C, and back again. Power is not applied during the test. After temperature cycling, the unit is placed in normal room ambient for at least 4 hours before power on.

Note 2: According to EN61000-4-2 , ESD class B: Some performance degradation allowed. No data lost. Self-recoverable. No hardware failures.

Note 3:

- Water condensation is not allowed for each test items.
- Each test is done by new TFT-LCD module. Don't use the same TFT-LCD module repeatedly for reliability test.
- The reliability test is performed only to examine the TFT-LCD module capability.
- To inspect TFT-LCD module after reliability test, please store it at room temperature and room humidity for 24 hours at least in advance.
- No function failure occurs.



Product Specification

AU OPTRONICS CORPORATION

G213UAN01.1

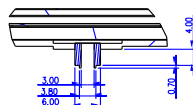
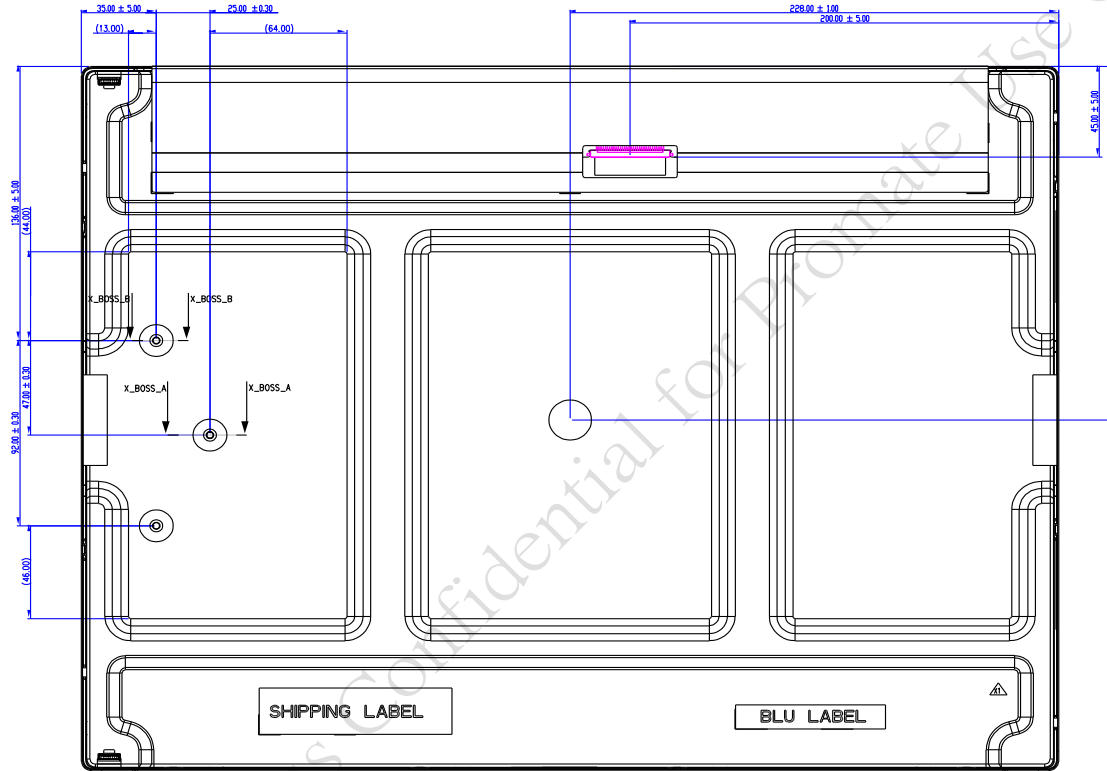

SECTION X_BOSS_A-X_BOSS_A
SCALE 2.000

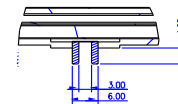

SECTION X_BOSS_B-X_BOSS_B
SCALE 2.000

9. Label and Packaging

9.1 Shipping Label (on the rear side of TFT-LCD display)



Note 1: For Pb Free products, AUO will add for identification.

Note 2: For RoHS compatible products, AUO will add for identification.

Note 3: For China RoHS compatible products, AUO will add for identification.

Note 4: The Green Mark will be presented only when the green documents have been ready by AUO Internal Green Team.

Note 5: The UL certification logo will be released when the design is fixed and pass the UL testing.

9.2 Carton Package

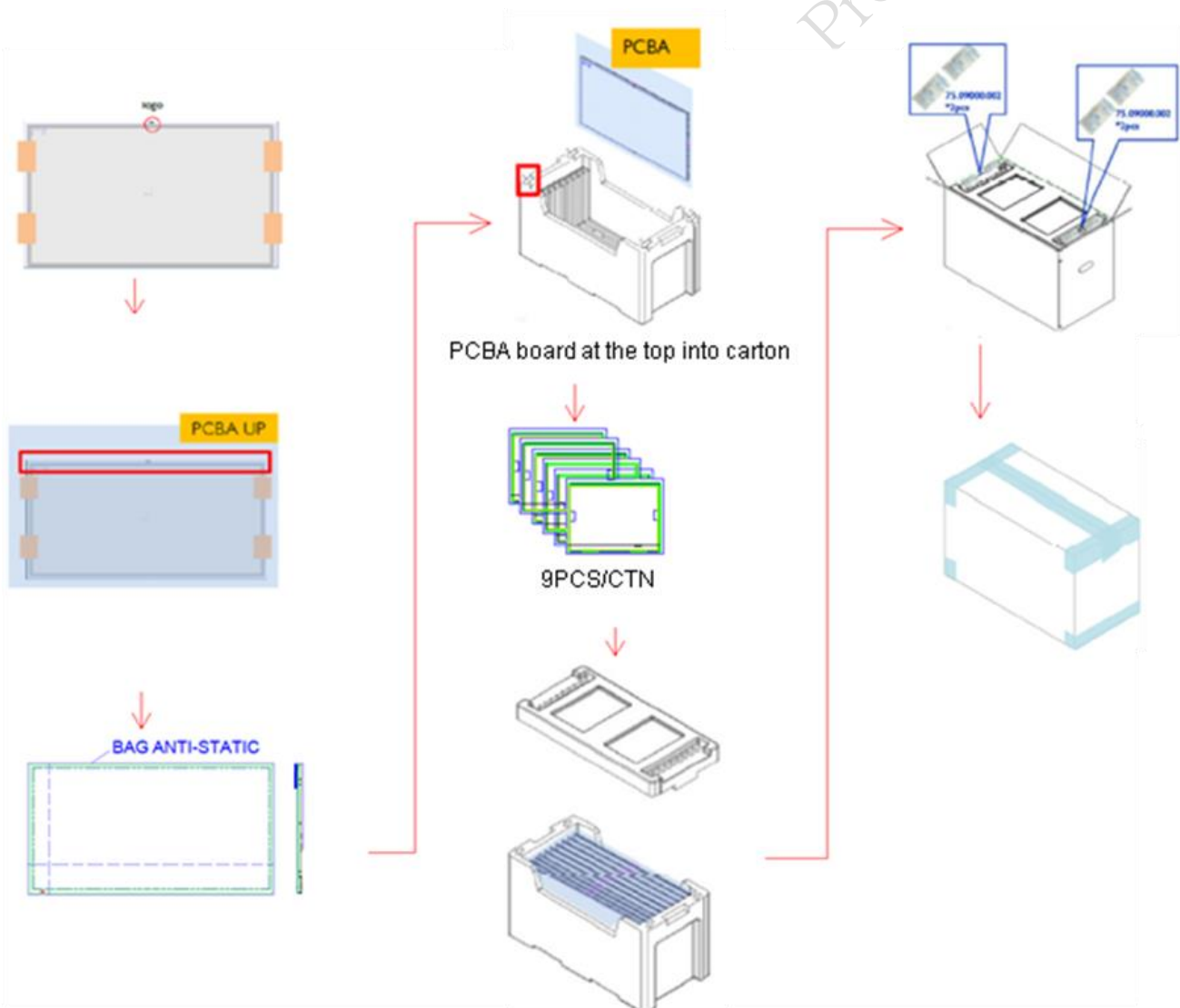



Max capacity : 9 PCS TFT-LCD module per carton

Max weight : about 23 kg per carton

Outside dimension of carton : 566mm(L)* 395mm(W)*466mm(H)

Pallet size : 1150 mm * 840 mm * 138mm

Box stacked

Module by air_Max : (2 *2) *3 layers , one pallet put 12 boxes , total 108pcs module

Module by sea_Max : (2 *2) *3 layers + (2 *2) *1 layer , two pallet put 16 boxes , total 144pcs module

Module by sea_HQ_Max : (2 *2) *3 layers + (2 *1) *1 layer , two pallet put 16 boxes , total 144pcs module

10 Safety

10.1 Sharp Edge Requirements

There will be no sharp edges or comers on the display assembly that could cause injury.

10.2 Materials

10.2.1 Toxicity

There will be no carcinogenic materials used anywhere in the display module. If toxic materials are used, they will be reviewed and approved by the responsible AUO toxicologist.

10.2.2 Flammability

All components including electrical components that do not meet the flammability grade UL94-V1 in the module will complete the flammability rating exception approval process.

The printed circuit board will be made from material rated 94-V1 or better. The actual UL flammability rating will be printed on the printed circuit board.

10.3 Capacitors

If any polarized capacitors are used in the display assembly, provisions will be made to keep them from being inserted backwards.

10.4 National Test Lab Requirement

The display module will satisfy all requirements for compliance to:

UL 60950-1 second edition

U.S.A. Information Technology Equipment